

UNIT – I

SOURCES AND DEMAND OF WATER

INTRODUCTION

Next to the air, the other important requirement for human life to exist is water. Water is available in various forms such as rivers, lake, streams etc.

The objectives of the community water supply system are

1. To provide wholesome water to the consumers for drinking purpose.
2. To supply adequate quantity to meet at least the minimum needs of the individuals.
3. To make adequate provisions for emergencies like fire-fighting, festivals, meeting etc.
4. To make provision for future demands due to increase in population, increase in standard of living, storage and conveyance.
5. To prevent pollution of water at source, storage and conveyance.
6. To maintain the treatment units and distribution system in good condition with adequate staff and materials.
7. To design and maintain the system that is economical and reliable.

WHOLE SOME WATER:

Absolutely pure water is never found in nature and which contains only two parts of hydrogen and one part of oxygen by volume. But the water found in nature contains number of impurities in varying amounts. The rainwater which is originally pure, also absorbs various gases, dust and other impurities while falling. This water when moves on the ground further carries silt, organic and inorganic impurities. The removal of the turbidity, odour and smell is considered as good and removal of dissolved substances is considered as “chemically pure”. But removal of substances like calcium, magnesium Iron, Zinc etc. completely is not good for health. These minerals are required for tissue growth and some act as prophylactic in preventing diseases. Therefore wholesome water is defined as the water which containing the minerals in small quantities at requisite levels and free from harmful impurities chemically pure water is also corrosive but not whole some water. The water that is fit for drinking safe and agreeable is called portable water.

The following are the requirements of wholesome water.

1. It should be free from bacteria



2. It should be colourless and sparkling
3. It should be tasty, odour free and cool
4. It should be free from objectionable matter
5. It should not corrode pipes
6. It should have dissolved oxygen and free from carbonic acid so that it may remain fresh.

SOURCES OF WATER:

All the sources of water can be broadly divided into

1. Surface sources and
2. Sub surface sources

The surface sources further divided into

- Streams
- Rivers
- Ponds
- Lakes
- Impounding reservoirs etc.

NATURAL PONDS AND LAKES

In mountains at some places natural basin's are formed with impervious bed by springs and streams are known as "lakes". The quality and quantity of water in the natural ponds and lakes depends upon the basin's capacity, catchment area, annual rainfall, porosity of ground etc. But lakes and ponds situated at higher altitudes contain almost pure water which can be used without any treatment. But ponds formed due to construction of houses, road, railways contains large amount of impurities and therefore cannot be used for water supply purposes.

STREAMS AND RIVER

Rivers and streams are the main source of surface source of water. In summer the quality of river water is better than monsoon. Because in rainy season the run-off water also carries with clay, sand, silt etc which make the water turbid. So the river and stream water require special treatments. Some rivers are snowfed and perennial have water throughout the year and therefore they do not require any arrangements to hold the water. But some rivers dry up wholly or partially in summer. So they require special arrangements to meet the water



demand during hot weather. Mostly all the cities are situated near the rivers discharge their used water of sewage in the rivers, therefore much care should be taken while drawing water from the river.

IMPOUNDING RESERVOIRS

In some rivers the flow becomes very small and cannot meet the requirements of hot weather. In such cases, the water can be stored by constructing a bund, a weir or a dam across the river at such places where minimum area of land is submerged in the water and max. quantity of water to be stored. In lakes and reservoirs, suspended impurities settle down in the bottom, but in their beds algae, weeds, vegetable and organic growth takes place which produce bad smell, taste and colour in water. Therefore this water should be used after purification. When water is stored for long time in reservoirs it should be aerated and chlorinated to kill the microscopic organisms which are born in water.

SUBSURFACE SOURCES

These are further divided into

- Infiltration galleries
- Infiltration wells
- Springs etc

INFILTRATION GALLERIES:

An infiltration gallery is a horizontal or nearly horizontal tunnel usually rectangular in cross section and having permeable boundaries so that ground water can infiltrate into the same, it is sometimes known as horizontal well. The yield from galleries may be 1.5×10^4 l/d/m length of infiltration gallery. For maximum yield the galleries may be placed at full depth of the aquifer. Infiltration galleries may be constructed with masonry with weep holes of 5cmx10cm.

INFILTRATION WELLS

In order to obtain large quantity of water, the infiltration wells are sunk in series in the banks of river. The wells are closed at top and open at bottom. They are constructed by brick masonry with open joints as shown.

For the purpose of inspection of well, the manholes are provided in the top cover. The water filtrates



through the bottom of such wells and as it has to pass through sand bed, it gets purified to some extent. The infiltration well inturn are connected by porous pipes to collecting sump called jackwell and there water is pumped to purification plant for treatment.

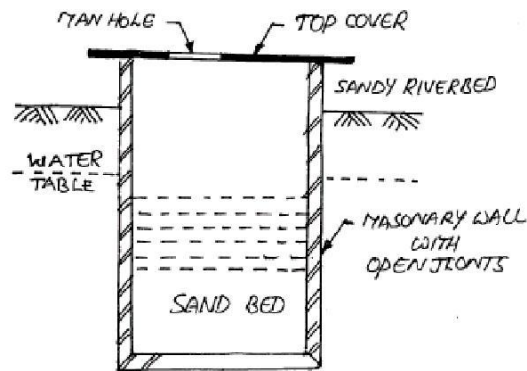

Infiltration Well

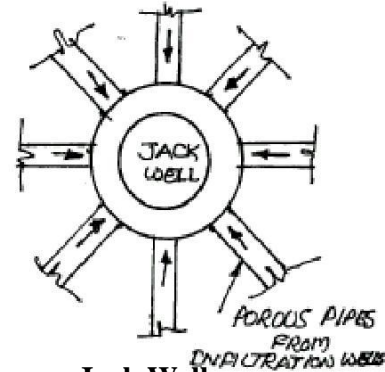

Jack Well

SPRINGS:

Sometimes ground water reappears at the ground surface in the form of springs. Springs generally supply small springs. Springs generally supply small quantity of water and hence suitable for the hill towns. Some springs discharge hot water due to presence of sulphur and useful only for the cure of certain skin disease patients.

Types of springs:

Gravity Springs: When the surface of the earth drops sharply the water bearing stratum is exposed to atmosphere and gravity springs are formed as shown

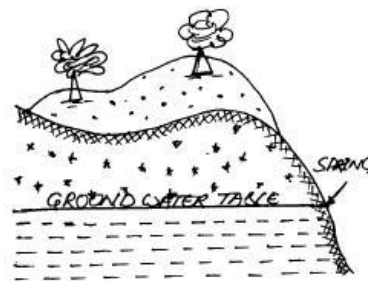

Gravity Spring

Surface Spring: This is formed when an impervious stratum which is supporting the ground water reservoir becomes out crops as shown.

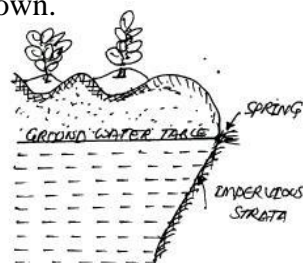

N.B.K.R. IN

VOLOGY: VIDYANAGAR

|| E-LEARNING ||

Prepared by Smt. S. Teja Reddy



Surface Spring



Artesian Spring: When the ground water rises through a fissure in the upper impervious stratum as shown

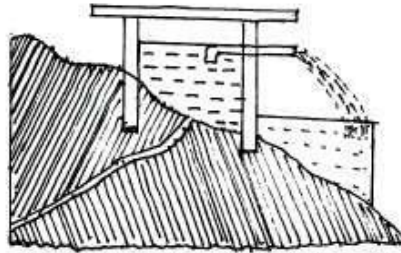

Artesian Spring

When the water-bearing stratum has too much hydraulic gradient and is closed between two impervious stratum, the formation of Artesian spring from deep seated spring

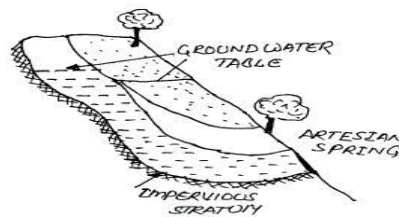

Artesian Spring

WELLS

A well is defined as an artificial hole or pit made in the ground for the purpose of tapping water. In India 75 to 85% of Indian population has to depend on wells for its water supply.

The three factors which form the basis of theory of wells are

- Geological conditions of the earth's surface
- Porosity of various layers
- Quantity of water, which is absorbed and stored in different layers.

The following are different types of wells

Shallow Wells :

Shallow wells are constructed in the uppermost layer of the earth's surface. The diameter of well varies from 2 to 6 m and a maximum depth of 7m. Shallow wells may be lined or unlined from inside. Fig. 3.9



Module - I

shows a shallow well with lining (steining). These wells are also called draw wells or gravity wells or open wells or drag wells or percolation wells.

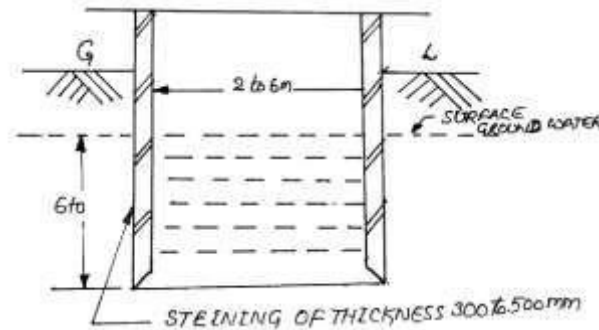

Shallow Well

Quantity of water available from shallow wells is limited as their source of supply is uppermost layer of earth only and sometimes may even dry up in summer. Hence they are not suitable for public water supply schemes. The quantity of water obtained from shallow wells is better than the river water but requires purification. The shallow wells should be constructed away from septic tanks, soak pits etc because of the contamination of effluent.

The shallow wells are used as the source of water supply for small villages, undeveloped municipal towns, isolated buildings etc because of limited supply and bad quality of water.

Deep Wells :

The Deep wells obtain their quota of water from an aquifer below the impervious layer as shown in fig. The theory of deep well is based on the travel of water from the outcrop to the site of deep well. The outcrop is the place where aquifer is exposed to the atmosphere. The rain water entered at outcrop and gets thoroughly purified when it reaches to the site of deep well. But it dissolves certain salts and therefore become hard. In such cases, some treatment would be necessary to remove the hardness of water.

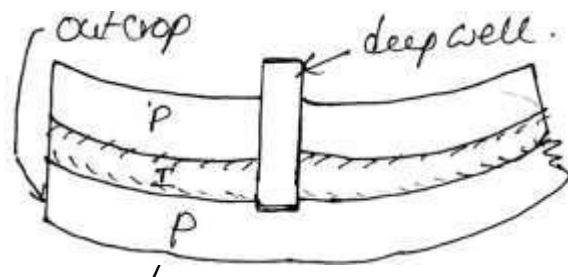

N.B.K.R. INSTITUTE OF SCIENCE & TECHNOLOGY: VIDYANAGAR

|| e-LEARNING ||

Prepared by Smt. S. Teja Reddy

Deep Well

The depth of deep well should be decided in such a way that the location of out crop is not very near to the site of well. The water available at a pressure greater atmospheric pressure, therefore deep wells are also referred to as a pressure wells.

WATER DEMAND

Various types of water demand

While designing the water supply scheme for a town or city, it is necessary to determine the total quantity of water required for various purposes by the city. As a matter of fact the first duty of the engineer is to determine the water demand of the town and then to find suitable water sources from where the demand can be met. But as there are so many factors involved in demand of water, it is not possible to accurately determine the actual demand. Certain empirical formulae and thumb rules are employed in determining the water demand, which is very near to the actual demand.

Following are the various types of water demands of a city or town:

- i. Domestic water demand
- ii. Municipal water demand
- iii. Industrial demand
- iv. Institution and commercial demand
- v. Demand for public use
- vi. Fire demand
- vii. Compensate Loses and wastes

DOMESTIC WATER DEMAND:

Domestic water demand includes water which is required for use in private residences, apartments etc., for bathing, cooking, washing, cleaning , lawn watering, gardening and sanitary purposes etc.,

Domestic water demand: 200 lpcd – higher sections (IS 1172 - 1993)

135 lpcd – weaker sections

340 lpcd for developed countries

The quantity of water demand for domestic purpose is around 50 – 60% of total water demand of the



INDUSTRIAL DEMAND

The water required in the industries mainly depends on the type of industries, which are existing in the city. The water required by factories, paper mills, Cloth mills, Cotton mills, Breweries, Sugar refineries etc. comes under industrial use. The quantity of water demand for industrial purpose is around 20 to 25% of the total demand of the city. On per capita basis it is around 50lpcd

INSTITUTIONAL AND COMMERCIAL DEMAND

Universities, Institution, commercial buildings and commercial centers including office buildings, warehouses, stores, hotels, shopping centers, health centers, schools, temple, cinema houses, railway and bus stations etc comes under this category. On per capita basis it is 20 lpcd for small cities, 50 lpcd for commercialized cities

DEMAND FOR PUBLIC USE

Quantity of water required for public utility purposes such as for washing and sprinkling on roads, cleaning of sewers, watering of public parks, gardens, public fountains etc comes under public demand. To meet the water demand for public use, provision of 5% of the total consumption is made designing the water works for a city. On per capita basis it is 10 lpcd.

The requirements of water for public utility shall be taken as given below

Sl.No.	Purpose	Water Requirements
1.	Public parks	1.4 litres/m ² /day
2.	Street washing	1.0-1.5 litres/m ² /day
3.	Sewer cleaning	4.5 litres/head/day

FIRE DEMAND

Fire may take place due to faulty electric wires by short circuiting, fire catching materials, explosions, bad intension of criminal people or any other unforeseen mishappenings. If fires are not properly controlled and extinguished in minimum possible time, they lead to serious damage and may burn cities.

All the big cities have full fire-fighting squads. As during the fire breakdown large quantity of water is required for throwing it over the fire to extinguish it, therefore provision is made in the water work to



Module - I

supply sufficient quantity of water or keep as reserve in the water mains for this purpose. In the cities fire hydrants are provided on the water mains at 100 to 150 m apart for fire demand.

The quantity of water required for fire- fighting is 1 lpcd

LOSSES AND WASTES

All the water, which goes in the distribution, pipes does not reach the consumers.

The following are the reasons

- Losses due to defective pipe joints, cracked and broken pipes, faulty valves and fittings
- Losses due to, consumers keep open their taps of public taps even when they are not using the water and allow the continuous wastage of water
- Losses due to unauthorized and illegal connections

While estimating the total quantity of water of a town; allowance of 15% of total quantity of water is made to compensate for losses, thefts and wastage of water.

FACTORS AFFECTING PER CAPITA DEMAND

The following factors are the main factors affecting the per capita demand of the town or city;

1. **Climatic conditions** : The quantity of water required in hotter and dry places is more than cold countries because of the use of air coolers, air conditioners, sprinkling of water in lawns, gardens, courtyards, washing of rooms, more washing of clothes and bathing etc. But in very cold countries sometimes the quantity of water required may be more due to wastage, because at such places the people often keep their taps open and water continuously flows for fear of freezing of water in the taps and use of hot water for keeping the rooms warm.
2. **Size of community** : Water demand is more with increase of size fo town because more water is required in street washing, running of sewers, maintenance of parks and gardens.
3. **Living standard of the people** : The per capita demand of the town increases with the standard of living of the people because of the use of air conditioners, room coolers, maintenance of lawns, use of flush, latrines and automatic home appliances etc.
4. **Industrial and commercial activities** : As the quantity of water required in certain industries is much more than domestic demand, their presence in the town will enormously increase per capita demand of the town. As a matter of the fact the water required by the industries has no direct link with the population of the town.



Module - I

5. **Pressure in the distribution system:** The rate of water consumption increase in the pressure of the building and even with the required pressure at the farthest point, the consumption of water will automatically increase. This increase in the quantity is firstly due to use of water freely by the people as compared when they get it scarcely and more water loss due to leakage, wastage and thefts etc.
6. **System of sanitation:** Per capita demand of the towns having water carriage system will be more than the town where this system is not being used.
7. **Cost of water:** The cost of water directly affects its demand. If the cost of water is more, less quantity of water will be used by the people as compared when the cost is low.

Variation in water demand:

- If average daily demand is supplied at all the times it will not be sufficient to meet needs because the demand varies from season to season more important from day to day and hour to hour.
- These variations are called fluctuations and are expressed as % of the annual average daily consumption.
- Seasonal variations are mainly due to the presence of the industries of a seasonal nature and domestic requirements.
- In summer, demand is maximum and this goes on reducing and in winter it becomes minimum.
- Daily and hourly variations are depends on the general habits of the people, climatic conditions and character of the city as industrial, commercial or residential.
- Demand fluctuations from day to day depends on the activity i.e., people draw more water on Sunday, compared to the rest of the days and the demand increases on the festival days.
- Hourly variations are very important as they have a wide range.
- In Indian cities the peak demand occurs in the morning hours during household activity from 6 to 10 AM and 4 to 8 PM in the evening.
- During the night hours i.e., 10 PM to 4 AM the consumption is below the average and is almost negligible.
- The excess water during the slack demand period is stored in a service reservoir, to be consumed during the periods of peak demand.
- Figure shows hourly variation of the rate of consumption throughout the day and the average consumption is shown in dotted lines.



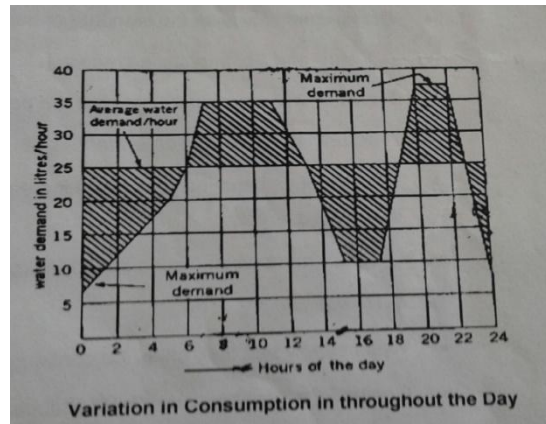

- Some common values are as under

Maximum seasonal consumption = 130% of annual average daily rate of demand

Maximum monthly consumption = 140% of annual average daily rate of demand

Maximum daily consumption = 180% of annual average daily rate of demand

Maximum hourly consumption = 270% of annual average daily rate of demand

VARIATIONS/FLUCTUATIONS IN DEMAND

The per capita demand of town is the average consumption of water for a year. In practice it has been seen that this demand does not remain uniform throughout the year but it varies from season to season, even hour to hour.

SEASONAL VARIATIONS

The water demand varies from season to season. In summer the water demand is maximum, because the people will use more water in bathing, cooling, lawn watering and street sprinkling. This demand will become minimum in winter because less water will be used in bathing and there will be no lawn watering. The variations may be **upto 15% of the average demand of the year.**

DAILY VARIATIONS

This variation depends on the general habits of people, climatic conditions and character of city as industrial, commercial or residential. More water demand will be on Sundays and holidays due to more comfortable bathing, washing etc as compared to other working days. The maximum daily consumption is usually taken as **180% of the average consumption.**

HOURLY VARIATIONS



Module - I

On Sundays and other holidays the peak hours may be about 8 A.M. due to late awakening where as it may be 6 A.M. to 10 A.M. and 4 P.M. to 8 P.M. and minimum flow may be between 12P.M. to 4P.M. when most of the people are sleeping. But in highly industrial city where both day and night shifts are working, the consumption in night may be more. The maximum consumption may be rise upto **270% that of average hourly demand.**

The determination of hourly variations is most necessary, because on its basis the rate of pumping will be adjusted to meet up the demand in all hours.

DESIGN PERIOD

The complete water supply project includes huge and costly constructions such as dams, reservoirs, treatment works and network of distribution pipelines. These all works cannot be replaced easily or capacities increased conveniently for future expansions.

While designing and constructing these works, they should have sufficient capacity to meet future demand of the town for number of years. The number of years for which the designs of the water works have been done is known as design period. Mostly water works are designed for design period of 22-30 years, which is fairly good period.

Factors affecting design period:

- Useful life of the pipes and equipment – if the useful life is more, design period is also more.
- Rate of growth of population – if the rate is more, design period is less.
- Rate of interest of loans for the project- if this rate is more the design period will be less.
- Efficiency of units of the project- more the efficiency, the longer the design period.

POPULATION FORECASTING METHODS

When the design period is fixed the next step is to determine the population of a town or city population of a town depends upon the factors like births, deaths, migration and annexation. The future development of the town mostly depends upon trade expansion, development industries, and surrounding country, discoveries of mines, construction of railway stations etc may produce sharp rises, slow growth, stationary conditions or even decrease the population. For the prediction of population, it is better to study the development of other similar towns, which have developed under the same circumstances, because the development of the predicted town will be more or less on the same lines.

The following are the standard methods by which the forecasting population is done

- Arithmetical increase method
- Geometrical increase method



Module - I

- Incremental increase method
- Simple graph method
- Decreasing rate of growth method
- Comparative graph method
- The master plan method

1. Arithmetical increase method:

- This method is based on assumption that the rate of change of population with time is constant.
- This method is suitable for large and old cities with considerable development. If it is used for small, average or comparatively new cities, it will give lower population estimate than actual value.
- In this method the average increase in population per decade is calculated from the past census reports and added to the present population to find out the population of next decade.
- It is assumed that the population is increasing at constant rate.

$$P_n = P_0 + nx$$

Where P_n = population to be forecasted after n decades

n = Number of decades between now and future

x = arithmetic mean of population increase in known decades.

P_0 = present population

2. Geometrical increase method:

- In this method the percentage increase in population from decade to decade is assumed to remain constant.
- Geometric mean increase is used to find out the future increment in population.
- Since this method gives higher values and hence should be applied for new or developing cities.

$$P_n = P_0 \left\{ 1 + \frac{r}{100} \right\}^n$$

Where P_n = population to be forecasted after n decades

n = Number of decades between now and future

r = growth rate = $\frac{\text{increase in population}}{\text{original population}} \times 100$ = average of all may be taken



$$\text{geometric mean } r = \sqrt[t]{r_1 \times r_2 \times r_3 \dots \dots r_n}$$

P_0 = present population

3. Incremental increase method:

- In this method population of each successive future decade is first worked out by the arithmetic increase method and to those values the average incremental increase per decade is added once for first future decade, twice for second future demand and so on.
- Suitable for an average size town under normal conditions where the growth rate is found to be in increasing order.

$$P_n = P_0 + nx + n \frac{n(n+1)}{2} y$$

Where P_n = population to be forecasted after n decades

n = Number of decades between now and future

x = arithmetic mean of population increase in known decades.

y = average incremental increase of known decades

P_0 = present population

4. Simple graph method:

- Populations of last few decades are correctly plotted to a suitable scale on graph.
- The population curve is smoothly extended for getting future population.
- This extension should be done carefully and it requires proper experience and judgment.
- The best way of applying this method is extend the curve by comparing with population of some other similar cities having similar growth condition.

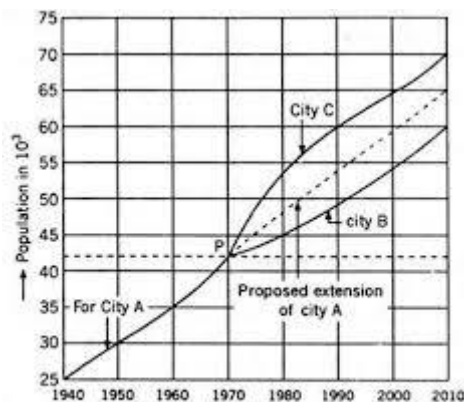

5. Comparative Graphical Method:

- In this method the census populations of cities already developed under similar



conditions are plotted.

- The curve of past population of the city under consideration is plotted on the same graph.
- The curve is extended carefully by comparing with the population curve of some similar cities having the similar condition of growth.
- The advantage of this method is that the future population can be predicted from the present population even in the absence of some of the past census report.

6. Master Plan Method:

- The big and metropolitan cities are generally not developed in haphazard manner, but are planned and regulated by local bodies according to master plan.
- The master plan is prepared for next 25 to 30 years for the city.
- According to the master plan the city is divided into various zones such as residence, commerce and industry.
- The population densities are fixed for various zones in the master plan. □ From this population density total water demand and wastewater generation for that zone can be worked out.
- By this method it is very easy to access precisely the design population.

7. Logistic Curve Method:

- This method is used when the growth rate of population due to births, deaths and migrations takes place under normal situation and it is not subjected to any extraordinary changes like epidemic, war, earth quake or any natural disaster, etc., and the population follows the growth curve characteristics of living things within limited space and economic opportunity.
- If the population of a city is plotted with respect to time, the curve so obtained under normal condition looks like S-shaped curve and is known as logistic curve



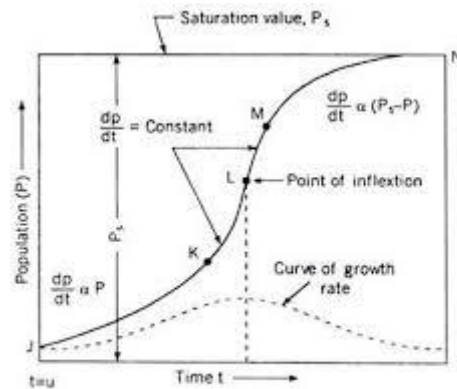

Fig. 5.3. Logistic curve.

INTAKES FOR COLLECTING SURFACE WATER:

The main function of the intakes works is to collect water from the surface source and then discharge water so collected, by means of pumps or directly to the treatment water. Intakes are structures which essentially consist of opening, grating or strainer through which the raw water from river, canal or reservoir enters and carried to the sump well by means of conducts water from the sump well is pumped through the rising mains to the treatment plant.

The following Points to be kept in mind for selecting intake

1. Where the best quality of water available so that water is purified economically in less time.
2. At site there should not be heavy current of water, which may damage the intake structure.
3. The intake can draw sufficient quantity of water even in the worst condition, when the discharge of the source is minimum.
4. The site of the work should be easily approachable without any obstruction
5. The site should not be located in navigation channels
6. As per as possible the intake should be near the treatment plant so that conveyance cost is reduced from source to the water works
7. As per as possible the intake should not be located in the vicinity of the point of sewage disposal for avoiding the pollution of water.
8. At the site sufficient quantity should be available for the future expansion of the water-works.

Types of Intake structures:

Depending upon the source of water the intake works are classified as following



1. Submerged Intake Structure:

- Simple concrete block supporting the starting end of the withdrawal pipe, covered by screen to prevent the entry of debris etc.
- Elevated 2 to 2.5m above the lake bed level to avoid entry of silt.
- They are cheap & do not obstruct navigation.
- Widely used for small water supply projects drawing water from streams or lakes having a little change in water level throughout year.
- Limitation: Not easily accessible for cleaning & repairing.

2. Intake Towers:

- They are widely used on large water supply projects drawing water from rivers or reservoirs having large change in water level.
- Gate controlled openings called Ports are provided at various levels in these concrete towers to regulate the flow.
- If the entry ports are submerged at all levels, there is no problem of any clogging or damage by debris etc.
- There are two major types of intake towers: (a) Wet intake towers (b) Dry intake towers

a. Dry Intake Towers:

- The water is directly drawn in to the withdrawal conduit through the gated entry ports.
- It has no water inside the tower if its gates are closed.
- When the entry ports are closed, a dry intake tower will be subjected to additional buoyant forces.
- Hence it must be of heavier construction than wet intake tower. Water can be withdrawn from any selected level of the reservoir by opening the gates.

b. Wet Intake Towers:

- It consist of a concrete circular shell filled with water up to the reservoir level and has a vertical inside shaft which is connected to the withdrawal pipe.
- The withdrawal pipe may lie over the bed of the rivers or may be in the form of tunnels below the river bed.
- Openings are made in to the outer concrete shell as well as, in to the inside shaft.
- Gates are usually placed on the shaft, so as to control the flow of water in to the shaft



and the withdrawal conduit.

- The water coming out of the withdrawal pipe may be taken to pump house for lift.

3. River Intake Structures:

- They are generally constructed for withdrawing water from almost all rivers. □ They can be classified in to two types (a) Twin well type of intake structure (b) Single well type of intake structure

a. Twin Well Type Intakes:

- They are constructed on almost all types of rivers, where the river water hugs the river bank.
- A typical river intake structure consists of 3 components an inlet well, inlet pipe or intake pipe, jack well.
- Inlet well is usually circular in c/s, made of masonry or concrete.
- Inlet pipe connects inlet well with jack well. It has a min dia of 45cm, laid at slope of 1 in 200. Flow velocity through it < 1.2m/s
- Water entering jack well is lifted by pumps & fed into the rising main □ Jack well should be founded on hard strata having B.C > 450 kN/m².

b. Single Well Type Intakes:

- No inlet well & inlet pipe in this type of river intake.
- Opening or ports fitted with bar screens are provided in the jack well itself.
- The sediment entering will usually be less, since clearer water will enter the off-take channel.
- The silt entering the jack well will partly settle down in the bottom silt zone of jack well or may be lifted up with the pumped water since pumps can easily lift sediment water. □ The jack well can be periodically cleaned manually, by stopping the water entry in to the well.

